

20W, 100-277Vac Input, Tunable White LED Driver

■ Features

- Supply Voltage: 90-305Vac
- 100,000Hour Life @ Tc=75C
- 7 Year Warranty
- 1% Dimmable
- Dim Off with 1W Standby Power
- Low Inrush Current
- Class II Driver
- ENEC/CB/CCC SELV Output
- Safety according to EN 61347-1, 61347-2-3
61347-2-13, 62384



■ Application

- Bay lights, Street lights, Tunnel lights, Flood lights

■ Model List

Model Number	Input Voltage Range	Output Power	Output Voltage	Output Current	Control Scheme	Certification (TBD)
BPR-020-D050-BNE	90~ 305Vac	20W	24-40Vdc	500mA	Tuya Bluetooth	CE/CCC
BPR-020-D050-ZNE	90~ 305Vac	20W	24-40Vdc	500mA	Tuya Zigbee	CE/CCC

■ Technical Data

Input Voltage	90 ~ 305Vac
Input Frequency	47 ~ 63Hz
Power Factor	>0.9@60-100%load, refer to PF vs. Load curve
THD	<20%@60-100%load, refer to THD vs. Load curve
Input Current	0.2Amax@220Vac & Full-Load
Inrush Current	0.2A peak, 0.2ms duration, <0.005A2s@220Vac, Cold Start
Leakage Current	1mA max @277Vac 60Hz, UL8750, 0.75mAmax @220Vac 50Hz, IEC61347-1
Input Under Voltage	Shut down and auto-recovery
Surge Protection	Line to line 1kV, line to ground 2kV, IEC 61000-4-5
Current Accuracy	±5%lo
Ripple Current	Ip-p:100%lo max, >1.25kHz PWM Output, flicker free equivalent
Setup Time	1.2s max
Overshoot	10% lo max & LED Load
Output Over Voltage	120% Vomax, typ.
Short Circuit	Auto recovery. The output recovers when short is removed.
Over Temperature	Lower the output current when $T_c \geq 90 \pm 10^\circ\text{C}$; Auto Recovery When $T_c \leq 50 \pm 10^\circ\text{C}$
Auxiliary Power (Vaux)	-
Operating Temperature	Case Temperature $T_c = 0^\circ\text{C} \sim +80^\circ\text{C}$; 10%RH ~ 100%RH
Storage Temperature	$-30^\circ\text{C} \sim +85^\circ\text{C}$; 5%RH ~ 100%RH
MTBF	$\geq 350,000$ hours, 50°C case temperature (MIL-HDBK-217F)
Lifetime	$\geq 100,000$ hours, 75°C case temperature, refer to life vs. T_c curve
Case Temperature	80°C max, marked in the T_c point of label
Dimensions	7.44x1.57x1.26 by inch 188.5x40.0x32.0 by mm
Net Weight	120g
Packing	-

Notes: Unless specified, all the test results are measured in 25°C room temperature.

* marked items are optional and contact with sales people to get the functions.

■ Safety/EMC Compliance

Safety Standard	Description
UL8750	Light emitting diode(LED) equipment for use in lighting products
UL1012/1310	Power units other than class 2 / Class 2 power units
IEC 61347-1	Lamp control gear Part 1: general and safety requirements
IEC 61347-2-13	Lamp control gear Part 2-13: particular requirement for d.c. or a.c. supplied electronic control gear for LED modules
EMI Standards	Description
IEC 55015	Conducted emission test & radiated emission test
IEC 61000-3-2	Harmonic current emissions; Class C
IEC 61000-3-3	Voltage fluctuations & flicker
FCC Part 15	ANSI C63.4:2009 Class B
EMS Standards	Description
IEC 61000-4-2	Electrostatic discharge (ESD): 8 kV air discharge, 4 kV contact discharge
IEC 61000-4-3	Radio frequency electromagnetic field susceptibility test (RS)
IEC 61000-4-4	Electrical fast transient (EFT)
IEC 61000-4-5	Surge immunity test
IEC 61000-4-6	Conducted radio frequency disturbances test (CS)
IEC 61000-4-8	Power frequency magnetic field test
IEC 61000-4-11	Voltage dips
IEC 61547	Electromagnetic immunity requirements applies to lighting equipment

■ Lifetime vs. Case Temperature

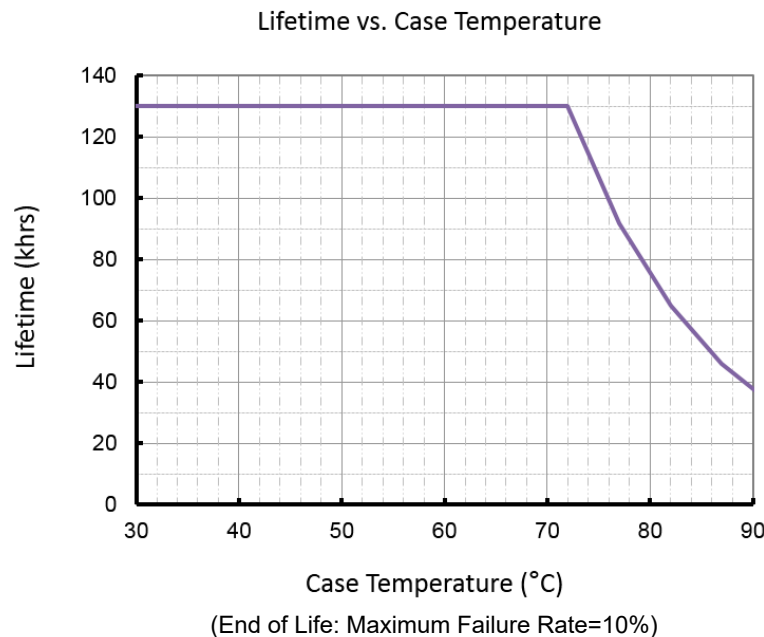

■ Mechanical Design

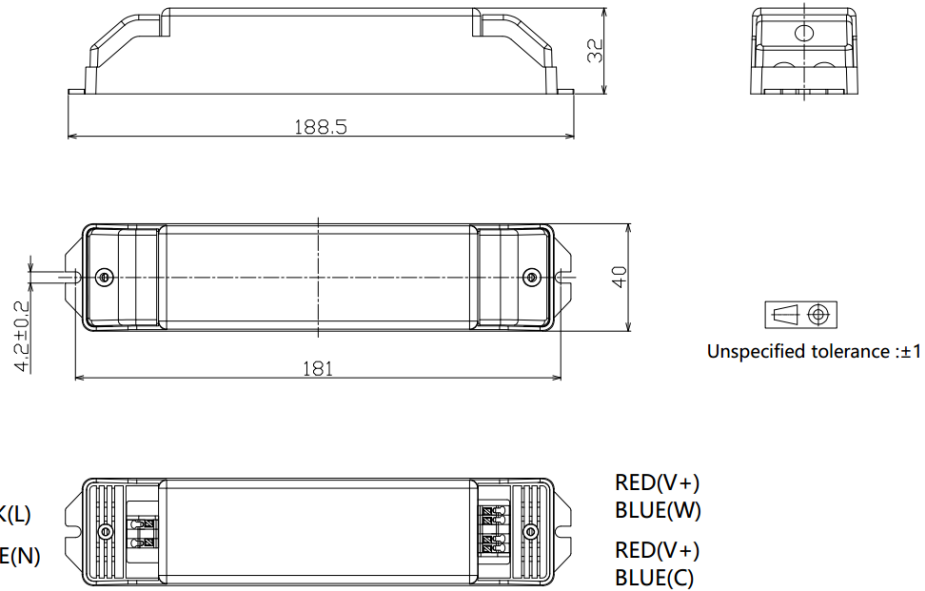

Note: Share V+ if there is only V+, W and C from the LED lights